

CP41A-PxS: P4 Orange LEDs



PRODUCT DESCRIPTION

P4 LEDs offer superior light output for excellent readability in sunlight and dependable performance. They provide extremely stable light output over long periods of time.

These lamps are made with an advanced optical-grade epoxy offering superior high-temperature and high-moisture-resistance performance in vehicle signal lamps and amusement lighting.

FEATURES

- Size (mm): 7.6 x 7.6
- Color and Typical Dominant Wavelength:
Orange (616nm)
- Viewing angles:
40°: CP41A-xDS
70°: CP41A-xFS
100°: CP41A-xHS
- Lead - Free
- RoHS Compliant

APPLICATIONS

- Channel Letter
- Amusement

ABSOLUTE MAXIMUM RATINGS ($T_A = 25^\circ\text{C}$)

Items	Symbol	Absolute Maximum Rating	Unit
Forward Current	I_F	70 ^{Note1}	mA
Peak Forward Current ^{Note2}	I_{FP}	100	mA
Reverse Voltage	V_R	5	V
Power Dissipation	P_D	210	mW
Operation Temperature	T_{opr}	-40 ~ +100	$^\circ\text{C}$
Storage Temperature	T_{stg}	-40 ~ +100	$^\circ\text{C}$
Lead Soldering Temperature	T_{sol}	Max. 260 $^\circ\text{C}$ for 5 sec. max. (3 mm from the base of the epoxy bulb)	
Electrostatic Discharge Classification (MIL-STD-883E)	ESD	Class 2	

Note:

1. A heat sink is recommended if the device is operated at ambient temperatures higher than 25 $^\circ\text{C}$.
2. Pulse width ≤ 0.1 msec, duty $\leq 1/10$.

TYPICAL ELECTRICAL & OPTICAL CHARACTERISTICS ($T_A = 25^\circ\text{C}$)

Characteristics	Color	Symbol	Condition	Unit	Minimum	Typical	Maximum
Forward Voltage	Orange	V_F	$I_F = 70$ mA	V		2.3	3.0
Reverse Current	Orange	I_R	$V_R = 5$ V	μA			100
Dominant Wavelength	Orange	λ_D	$I_F = 70$ mA	nm	612	616	618
Luminous Flux	Orange	CP41A-PDS (40 degree)	Φ_v	$I_F = 70$ mA	mlm	4400	6300
		CP41A-PFS (70 degree)	Φ_v	$I_F = 70$ mA	mlm	4400	6500
		CP41A-PHS (100 degree)	Φ_v	$I_F = 70$ mA	mlm	4400	7000
50% Power Angle	CP41A-PDS		$2\theta_{1/2}$	$I_F = 70$ mA	deg		40
	CP41A-PFS		$2\theta_{1/2}$	$I_F = 70$ mA	deg		70
	CP41A-PHS		$2\theta_{1/2}$	$I_F = 70$ mA	deg		100

* Continuous reverse voltage can cause LED damage.

FLUX BIN LIMIT

Orange (70 mA) - CP41A-PDS			Orange(70 mA) - CP41A-PFS/PHS		
Bin Code	Min.(mlm)	Max.(mlm)	Bin Code	Min.(mlm)	Max.(mlm)
L0	4400	5500	L0	4400	5500
M0	5500	6600	M0	5500	6600
N0	6600	8730	N0	6600	8730
			P0	8730	11000

* Tolerance of measurement of luminous flux is $\pm 15\%$

COLOR BIN LIMIT

Orange (70 mA) - CP41A-PDS/PFS/PHS		
Bin Code	Min.(nm)	Max.(nm)
PJ	612	618

* Tolerance of measurement of dominant wavelength is ± 1 nm.

VOLTAGE BIN LIMIT

Red & Amber		
Bin Code	Min. (V)	Max. (V)
22	1.8	2.0
23	2.0	2.2
24	2.2	2.4
25	2.4	2.6
26	2.6	2.8
27	2.8	3.0

* Tolerance of measurement of voltage is $\pm 0.05V$

ORDER CODE TABLE

Color	Viewing Angle	Kit Number	Luminous Flux (lm)		Dominant Wavelength			
			Min.	Max.	Color Bin	Min.(nm)	Color Bin	Max.(nm)
Orange	40°	CP41A-PDS-CL0N0JJ4	4400	8730	PJ	612	PJ	618
		CP41A-PDS-CM0N0JJ4	5500	8730	PJ	612	PJ	618
	70°	CP41A-PFS-CL0P0JJ4	4400	11000	PJ	612	PJ	618
		CP41A-PFS-CM0P0JJ4	5500	11000	PJ	612	PJ	618
	100°	CP41A-PHS-CL0P0JJ4	4400	11000	PJ	612	PJ	618
		CP41A-PHS-CM0P0JJ4	5500	11000	PJ	612	PJ	618

Notes:

- The above kit numbers represent order codes which include multiple flux-bin and color-bin codes. Only one flux-bin code and one color-bin code will be shipped on each reel. And single flux-bin code, single color bin-codes will not be orderable.
- Please refer to the [HB LED Lamp Reliability Test Standards](#) document for reliability test conditions.
- Please refer to the [HB LED Lamp Soldering & Handling](#) document for information about how to use this LED product safely.

GRAPHS

The data below are collected from statistical figures that do not necessarily correspond to the actual parameters of each single LED. Hence, these data will be changed without further notice.

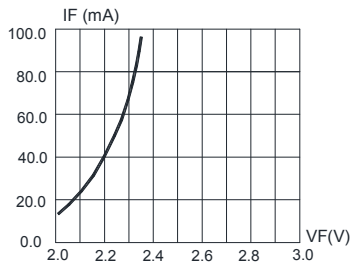

FIG.1 FORWARD CURRENT VS. FORWARD VOLTAGE.

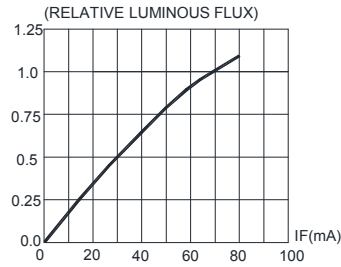

FIG.2 RELATIVE LUMINOUS FLUX VS. FORWARD CURRENT

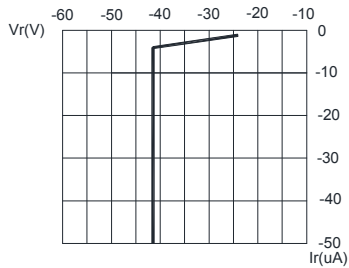

FIG.3 Red & Amber REVERSE CURRENT VS. REVERSE VOLTAGE.

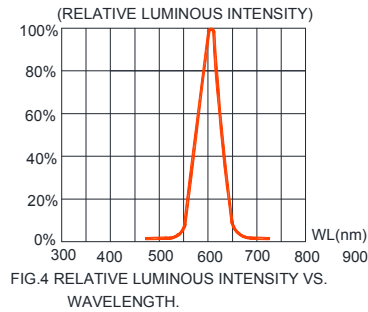

FIG.4 RELATIVE LUMINOUS INTENSITY VS. WAVELENGTH.

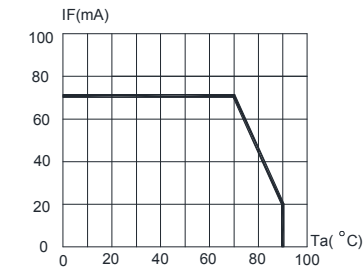

FIG.5 Red & Amber MAXIMUM FORWARD DC CURRENT VS AMBIENT TEMPERATURE (Tjmax=110°C)

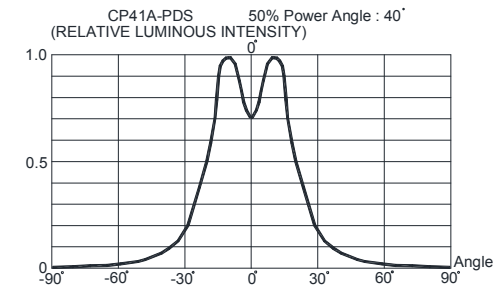

FIG.6 FAR FIELD PATTERN

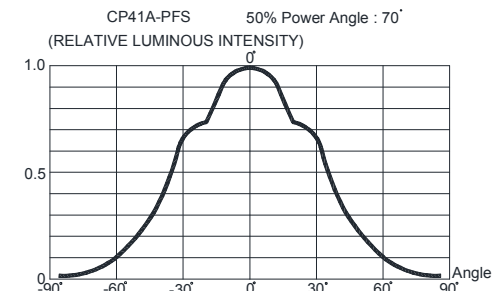

FIG.7 FAR FIELD PATTERN

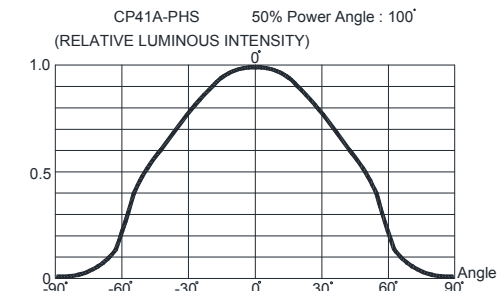

FIG.8 FAR FIELD PATTERN

MECHANICAL DIMENSIONS

All dimensions are in mm. Tolerance is ± 0.25 mm unless otherwise noted.

An epoxy meniscus extend about 1.5 mm down the leads.

All metal burr dimension is 0.2 mm max.

CP41A-PDS:

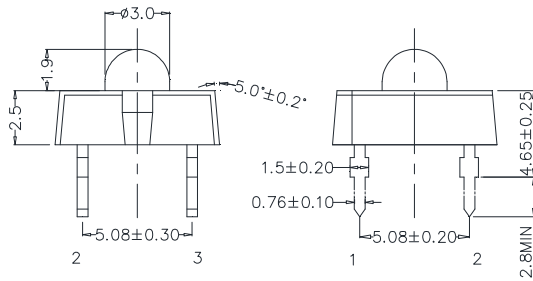

2,3: ANODE
1,4: CATHODE

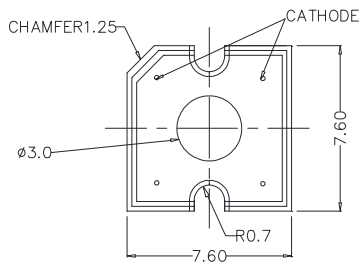

CP41A-PFS:

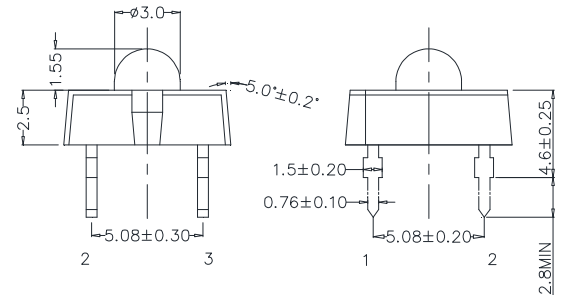

2,3: ANODE
1,4: CATHODE

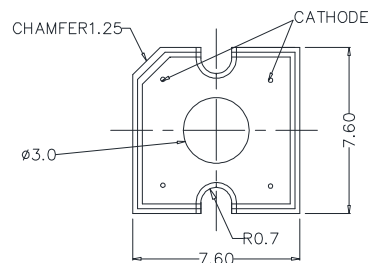

NOTES

RoHS Compliance

The levels of RoHS restricted materials in this product are below the maximum concentration values (also referred to as the threshold limits) permitted for such substances, or are used in an exempted application, in accordance with EU Directive 2011/65/EC (RoHS2), as implemented January 2, 2013. RoHS Declarations for this product can be obtained from your Cree LED representative or from the [Product Ecology](#) section of the Cree LED website.

Vision Advisory

WARNING: Do not look at an exposed lamp in operation. Eye injury can result.

MECHANICAL DIMENSIONS

All dimensions are in mm. Tolerance is ± 0.25 mm unless otherwise noted.

An epoxy meniscus extend about 1.5 mm down the leads.

All metal burr dimension is 0.2 mm max.

CP41A-PHS:

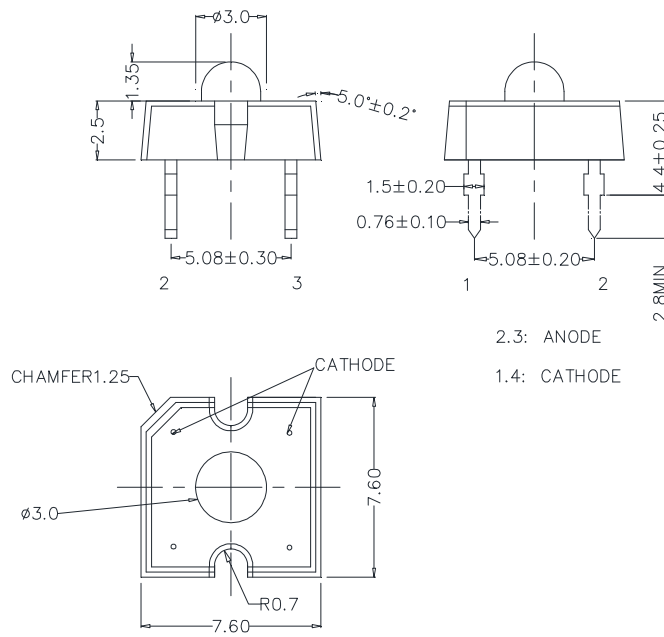

NOTES

RoHS Compliance

The levels of RoHS restricted materials in this product are below the maximum concentration values (also referred to as the threshold limits) permitted for such substances, or are used in an exempted application, in accordance with EU Directive 2011/65/EC (RoHS2), as implemented January 2, 2013. RoHS Declarations for this product can be obtained from your Cree LED representative or from the [Product Ecology](#) section of the Cree LED website.

Vision Advisory

WARNING: Do not look at an exposed lamp in operation. Eye injury can result.

KIT NUMBER SYSTEM

Cree LED lamps are tested and sorted into performance bins. A bin is specified by ranges of color, forward voltage, and brightness. Sorted LEDs are packaged for shipping in various convenient options.

Cree LEDs are sold by order codes in combinations of bins called kits. Order codes are configured in the following manner:

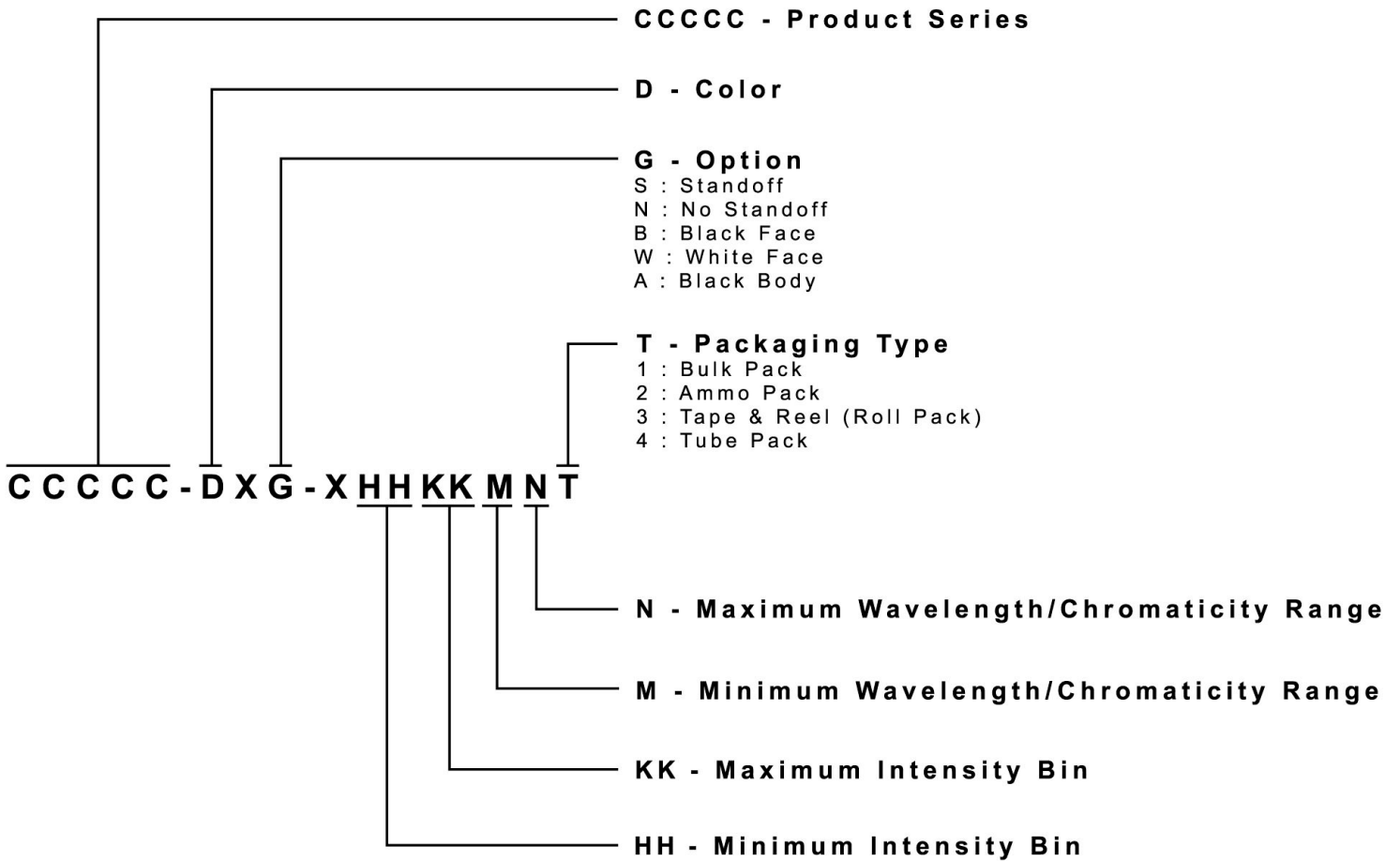

SOLDERING GUIDELINES

The LED soldering specification is shown below (suitable for both leaded solder & lead-free solder):

Manual Soldering		Solder Dipping	
Soldering iron	35 W max	Preheat	110 °C max
Temperature	300 °C max	Preheat time	60 seconds max
		Solder-bath temperature	260 °C Max
Soldering time	3 seconds max	Dipping time	5 seconds max
Position	Not less than 3 mm from the base of the package.	Position	Not less than 3 mm from the base of the package.

- Manual soldering onto the PCB is not recommended because soldering time is uncontrollable.
- The recommended wave soldering is as below:

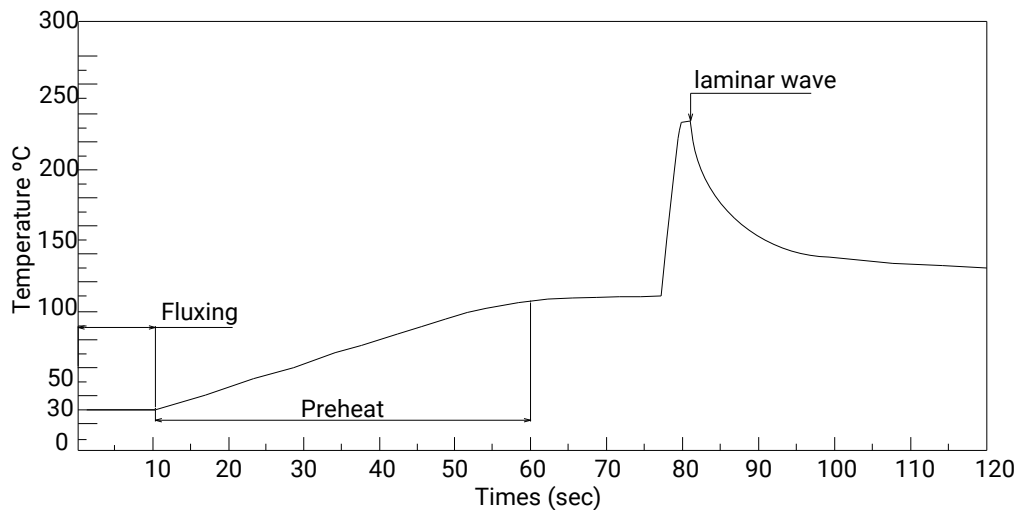

- Do not apply any stress to the LED package, particularly when heated.
- Only bottom preheat is suggested & should not preheat on top in order to reduce thermal stress experienced by the LEDs.
- The LEDs must not be re used once they have been extracted from PCB.
- After soldering the LEDs, the package should be protected from mechanical shock or vibration until the LEDs have reached 40 °C or below.
- Precautions must be taken as mechanical stress on the LEDs may be caused by PCB warpage or from the clinching and cutting of the LED leads.
- When it is necessary to clamp the LEDs during soldering, it is important to ensure no mechanical stress is exerted on the LEDs.
- Cut the LED lead at normal room temperature. Lead cutting at high temperature may cause failure of the LEDs.
- Please refer to the [HB LED Lamp Soldering & Handling](#) document for information about how to use this LED product safely.

PACKAGING

- The LEDs are packed in cardboard boxes after packaging in normal or anti-electrostatic bags.
- Cardboard boxes will be used to protect the LEDs from mechanical shock during transportation.
- The boxes are not water resistant, and they must be kept away from water and moisture.
- The Tube Pack type of packaging. Max 60 pcs per tube.

