

CLM4B-RKC/AKC: PLCC4 1 IN 1 SMD LED

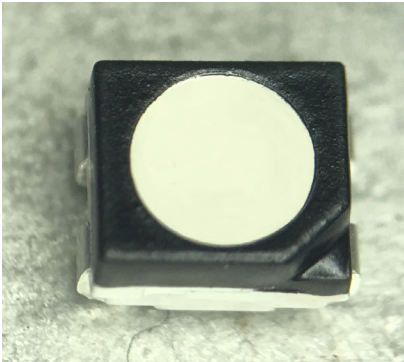

PRODUCT DESCRIPTION

SMD LEDs is packaged in the industry standard package. These LEDs have high reliability performance and are designed to work under a wide range of environmental conditions.

This high reliability feature makes them ideally suited to be used under illumination application conditions.

Its wide viewing angle makes these LEDs ideally suited for channel letter, or general backlighting and illumination applications. The flat top emitting surface makes it easy for these LEDs to mate with light pipes.

FEATURES

- Size (mm): 3.2 X 2.8
- Color and Typical Dominant Wavelength:
Red (624nm)
Amber (591nm)
- Luminous Intensity (mcd)
CLM4B-RKC:(1120-2240)
CLM4B-AKC:(1400-2800)
- Lead - Free
- RoHS Compliant

APPLICATIONS

- Channel Letter
- Architectural Lighting

ABSOLUTE MAXIMUM RATINGS ($T_A = 25^\circ\text{C}$)

Items	Color	Symbol	Absolute Maximum Rating	Unit
Forward Current	Red/Amber	I_F	70	mA
Peak Forward Current ^{Note1}	Red/Amber	I_{FP}	200	mA
Reverse Voltage	Red/Amber	V_R	5	V
Power Dissipation	Red	P_D	210	mW
Power Dissipation	Amber	P_D	182	mW
Operation Temperature	Red/Amber	T_{opr}	-40 ~ +100	$^\circ\text{C}$
Storage Temperature	Red/Amber	T_{stg}	-40 ~ +100	$^\circ\text{C}$
Junction Temperature	Red/Amber	T_J	110	$^\circ\text{C}$
Junction/Ambient	Red	R_{THJA}	270	$^\circ\text{C/W}$
Junction/Ambient	Amber	R_{THJA}	240	$^\circ\text{C/W}$
Junction/Solder Point	Red	R_{THJS}	130	$^\circ\text{C/W}$
Junction/Solder Point	Amber	R_{THJS}	120	$^\circ\text{C/W}$
Electrostatic Discharge Classification (MIL-STD-883E)	Red/Amber	ESD	Class 2	

Note:

1. Pulse width ≤ 0.1 msec, duty $\leq 1/10$.

TYPICAL ELECTRICAL & OPTICAL CHARACTERISTICS ($T_A = 25^\circ\text{C}$)

Characteristics	Color	Symbol	Condition	Unit	Minimum	Typical	Maximum
Forward Voltage	Red	V_F	$I_F = 50$ mA	V		2.5	3.0
Forward Voltage	Amber	V_F	$I_F = 50$ mA	V		2.2	2.6
Reverse Current	Red/Amber	I_R	$V_R = 5$ V	μA			10
Dominant Wavelength	Red	λ_D	$I_F = 50$ mA	nm	618	624	630
	Amber	λ_D	$I_F = 50$ mA	nm	587	591	596
Luminous Intensity	Red	I_V	$I_F = 50$ mA	mcd	1120	1700	
	Amber	I_V	$I_F = 50$ mA	mcd	1400	1900	

* Continuous reverse voltage can cause LED damage.

INTENSITY BIN LIMIT

Red(50 mA) - CLM4B-RKC			Amber (50 mA) - CLM4B-AKC		
Bin Code	Min.(mcd)	Max.(mcd)	Bin Code	Min.(mcd)	Max.(mcd)
Wa	1120	1400	Wb	1400	1800
Wb	1400	1800	Xa	1800	2240
Xa	1800	2240	Xb	2240	2800

* Tolerance of measurement of luminous intensity is $\pm 10\%$

COLOR BIN LIMIT

Red (50 mA) - CLM4B-RKC			Amber (50 mA) - CLM4B-AKC		
Bin Code	Min.(nm)	Max.(nm)	Bin Code	Min.(nm)	Max.(nm)
RA	618	630	A3	587	590
			A4	590	593
			A5	593	596

* Tolerance of measurement of dominant wavelength is ± 1 nm

ORDER CODE TABLE

Color	Kit Number	Luminous Intensity (mcd)		Dominant Wavelength			
		Min.	Max.	Color Bin	Min. (nm)	Color Bin	Max. (nm)
Red	CLM4B-RKC-CWaXaAA3	1120	2240	RA	618	RA	630
Red	CLM4B-RKC-CWbXaAA3	1400	2240	RA	618	RA	630

Color	Kit Number	Luminous Intensity (mcd)		Dominant Wavelength			
		Min.	Max.	Color Bin	Min. (nm)	Color Bin	Max. (nm)
Amber	CLM4B-AKC-CWbXb353	1400	2800	A3	587	A5	596
Amber	CLM4B-AKC-CWbXb343	1400	2800	A3	587	A4	593

Notes:

- The above kit numbers represent order codes that include multiple intensity-bin and color-bin codes. Only one intensity-bin code and one color-bin code will be shipped on each bulk. Single intensity-bin code and single color-bin codes will not be orderable.
- Please refer to the [HB LED Lamp Reliability Test Standards](#) document for reliability test conditions.
- Please refer to the [HB LED Lamp Soldering & Handling](#) document for information about how to use this LED product safely.

GRAPHS

The data below are collected from statistical figures that do not necessarily correspond to the actual parameters of each single LED. Hence, these data will be changed without further notice.

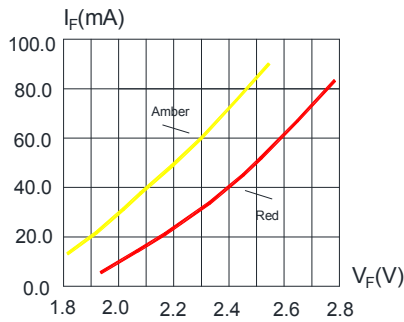

FIG.1 FORWARD CURRENT VS. FORWARD VOLTAGE.

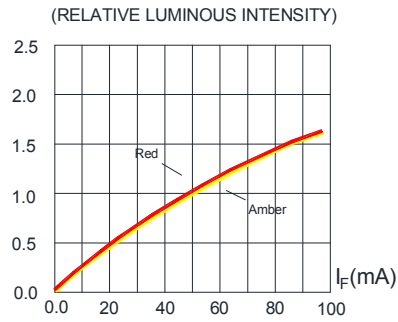

FIG.2 RELATIVE LUMINOUS INTENSITY VS. FORWARD CURRENT

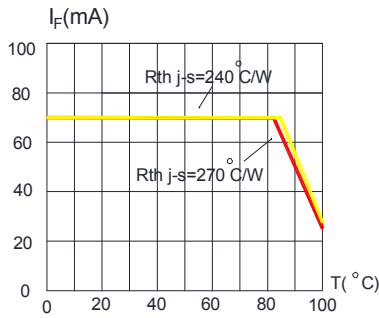

FIG.3 RED&AMBER MAXIMUM FORWARD DC CURRENT VS SOLDER TEMPERATURE (T_{jmax}=110 °C)

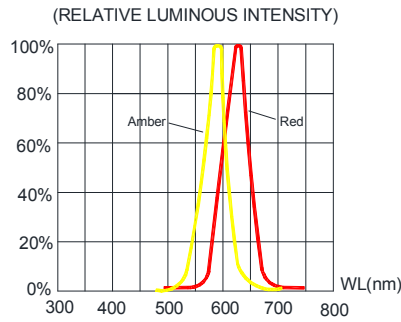

FIG.4 RELATIVE LUMINOUS INTENSITY VS. WAVELENGTH.

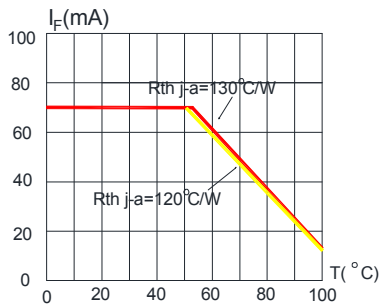

FIG.5 RED&AMBER MAXIMUM FORWARD DC CURRENT VS AMBIENT TEMPERATURE (T_{jmax}=110 °C)

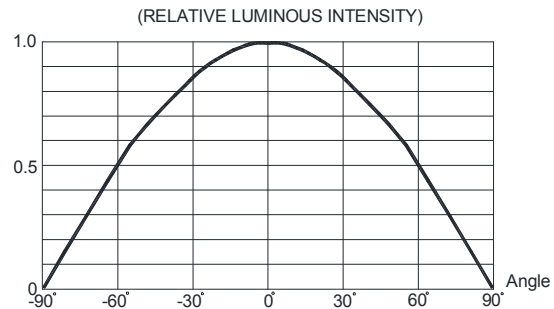
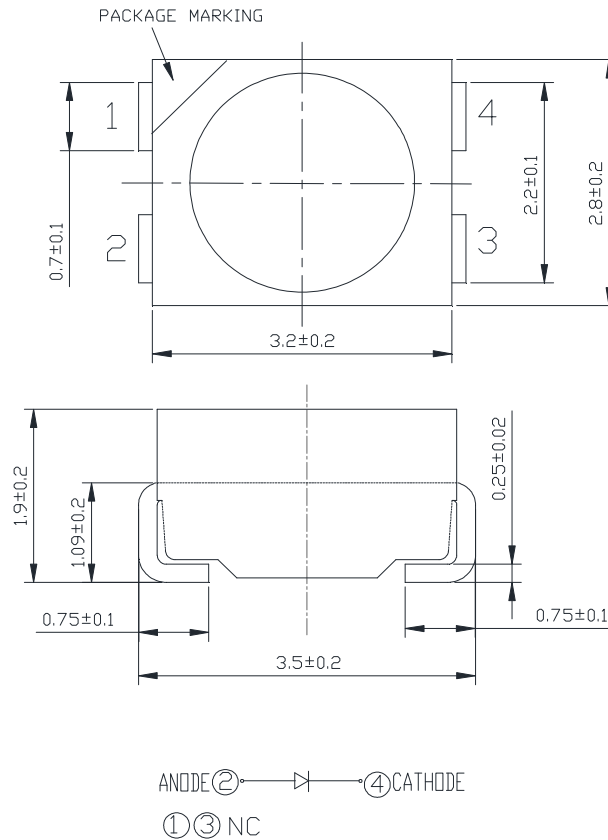

FIG.6 FAR FIELD PATTERN

MECHANICAL DIMENSIONS

All dimensions are in mm.



NOTES

RoHS Compliance

The levels of RoHS restricted materials in this product are below the maximum concentration values (also referred to as the threshold limits) permitted for such substances, or are used in an exempted application, in accordance with EU Directive 2011/65/EC (RoHS2), as implemented January 2, 2013. RoHS Declarations for this product can be obtained from your Cree LED representative or from the [Product Ecology](#) section of the Cree LED website.

Vision Advisory

WARNING: Do not look at an exposed lamp in operation. Eye injury can result.

KIT NUMBER SYSTEM

Cree LED lamps are tested and sorted into performance bins. A bin is specified by ranges of color, forward voltage, and brightness. Sorted LEDs are packaged for shipping in various convenient options.

Cree LEDs are sold by order codes in combinations of bins called kits. Order codes are configured in the following manner:



REFLOW SOLDERING

- The CLM4B-RKC/AKC is rated as a MSL 5a product.
- The recommended floor life out of bag is 24hrs.
- The temperature profile is as below.

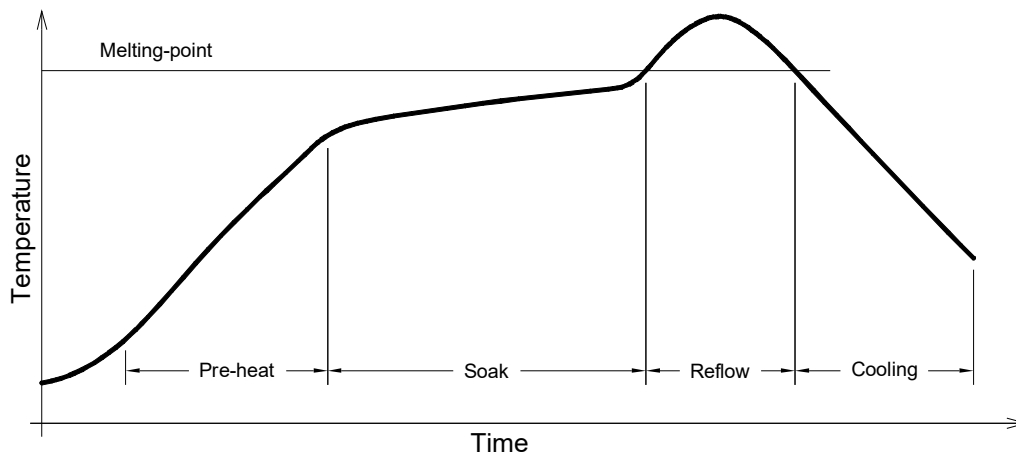

Use only with CLM4B-RKC/AKC

Solder
Average ramp-up rate = 4°C/s max
Preheat temperature = 150°C ~200°C
Preheat time = 120s max
Ramp-down rate = 6°C/s max
Peak temperature = 235°C max
Time within 5°C of actual Peak Temperature = 10s max
Duration above 217°C is 45s max

- The packaging sizes of these SMD products are very small and the resin is still soft after solidification. Users are required to handle with care. Never touch the resin surface of SMD products.
- To avoid damaging the product's surface and interior device, it is recommended to choose a special nozzle to pick up the SMD products during the process of SMT production. If handling is necessary, take special care when picking up these products. The following method is necessary:
- Please refer to the [HB LED Lamp Soldering & Handling](#) document for information about how to use this LED product safely.

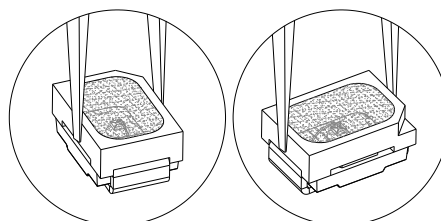

PACKAGING

- The LEDs are packed in cardboard boxes after packaging in normal or anti-electrostatic bags.
- Cardboard boxes will be used to protect the LEDs from mechanical shock during transportation.
- The boxes are not water resistant, and they must be kept away from water and moisture.
- The reel pack is applied in SMD LED.
- Max 2000 pcs per reel.

